

Article number: 204490ZD502SR
 Description: E+G Ball catches
 GN 4490-ZD-50-2-SR

Measures

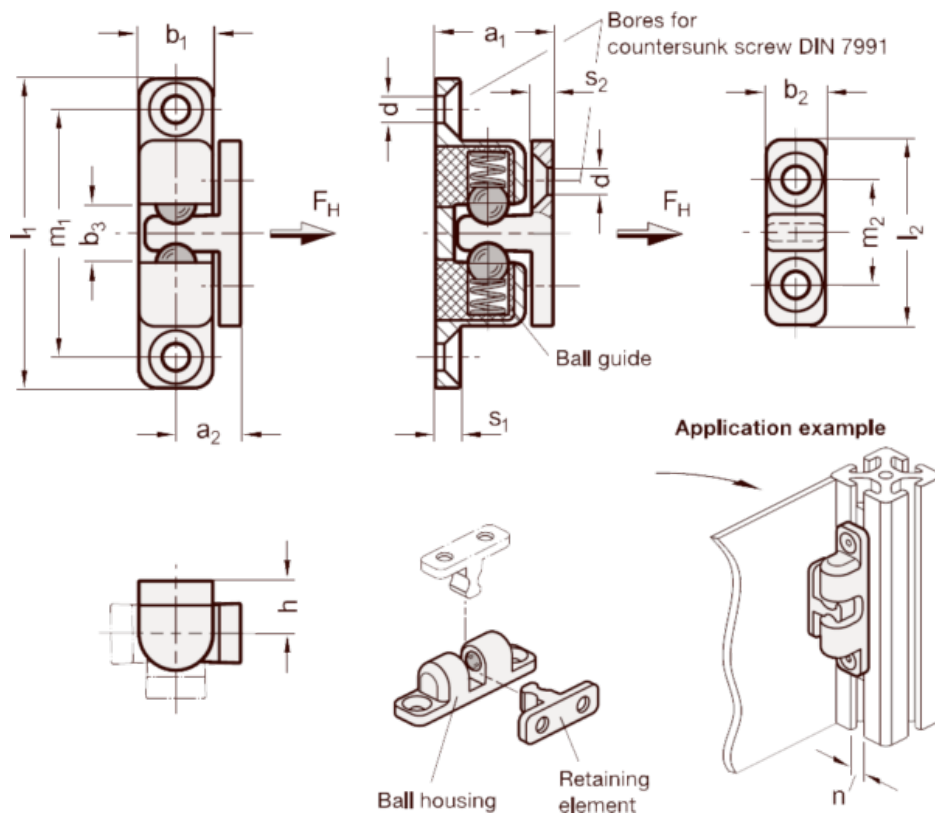

a1	= 20	Holding force FH in N	= 55
a2	= 10.5	l1	= 50
b1	= 12	l2	= 30
b2	= 10	m1	= 40
b3	= 6.5	m2	= 17
d	= M 4	s1	= 5
for nut width n	= ? 6	s2	= 3.5
h	= 9.5	Weight in (g)	= 31